

Industrial enhanced-safety radio remote controls

UD Series

Prize of design 2001
Prize of innovation 2001



Typical applications :

- ◆ **Industrial lifting**
 - Travelling cranes, gantry cranes
 - Monorails, Hoists, jib cranes
- ◆ **Industrial equipment**
 - Handling systems
 - Dynamic storage
 - Ovens
 - Transfer cranes
- ◆ **Industrial vehicles**
 - Bulk product transport
 - Animal feed transport
 - Sanitation
 - Aircraft pushers
- ◆ **Construction**
 - Tower cranes
 - Concrete pumps



1- Description

▶▶▶ A radio remote control provides numerous advantages:

- Large freedom of movement
- Easy to use
- Precise, quality manoeuvres
- Visibility
- Productivity

▶▶▶ With the UD radio remote controls, Jay Electronique provides solutions to the broad range of enhanced-safety industrial applications implementing button controls. By its modular design, Jay electronique's UD system integrates a number of features in terms of:

- Number of function buttons
- Type of function buttons
- Position of function buttons
- Number of output relays
- Programming of relay / buttons assignments

▶▶▶ Special attention has been given to ensure operator comfort through the following features:

- Ergonomic transmitters enabling one-hand control
- Control button accessibility
- Button touch sensitivity
- Identification of controlled functions
- Light-weight compact transmitters
- Transmitter endurance, and fast, easy to replace plug-in battery pack
- Adaptability to all radio configurations of the environment by possibility for changing frequency by a trained operator
- Mechanical protection of function buttons to avoid any unintentional action
- Transmitter handle for belt fastening clip when unit is idle or removable shoulder strap (optional accessories)

▶▶▶ The receiver is also very easy to install:

- Compact receiver
- Spring-type connection terminals

▶▶▶ To further enhance safety when using this equipment, technical solutions and innovative options are also proposed:

- Access is enabled by electronic key to an authorised operator only
- Infrared start-up validation (option) to limit startup in a given area and ensure identification of equipment started up
- Memorisation of use of remote control by recording number of operations and durations for each movement (option)

▶▶▶ Easy maintenance:

- Customization entirely stored in electronic key
- Parameter definition software (option)
- Diagnostic aid indicator lights

CONTENTS

Para.	Page
1	Description 1
2	Product features 2
3	Additional options 3
4	Safety aspects 6
5	Compatibility 6
6	Radio frequencies 6
7	Technical characteristics 7
8	Dimensions 8
9	Selection guide 9

● Compliance with European directives:

- Machinery
Cat.3 safety stop as defined by EN954-1
- Hertzian equipment and telecommunication terminals (low voltage, EM compatibility, radiofrequency spectrum)
ART conformity certificate

● Compliance with applicatives standards :

- EN15011 (travelling cranes)
- EN13557 (lifting machines with suspended load)

JAY
électronique

E330 E - 0807

revision01

2- Product features

2.1 Transmitter UDE

The transmitters come in 2 models : 6 function buttons **or** 10 function buttons.
Each model also contains a «On/Horn» button and an emergency stop palmswitch.

The unit's highly modular design allows for installation, in each location, of 6 different types of function buttons as described below :

- One-step pushbutton (single speed)
- Two-step pushbutton (double speed)
- Rotary switch with 2 fixed positions
- Rotary switch with 3 fixed positions
- Rotary switch with 3 positions with automatic return
- Electronic switch with 3 fixed positions

Two parameters can be easily adapted to the environment by a trained operator :

- Operating radio frequency
- Duration of temporization for «dead man» function (Automatic shutdown of remote control in case of prolonged non use)

These operations are performed by procedures implementing buttons n°1, n°2, n°3, the emergency stop palmswitch and the «On/Horn» button, with no need to open the transmitter or receiver.

The change of parameter can be however locked.

The electronic key contains all the parameters of the remote control, it is possible to use an auxiliary transmitter only with the electronic key and a validation procedure.

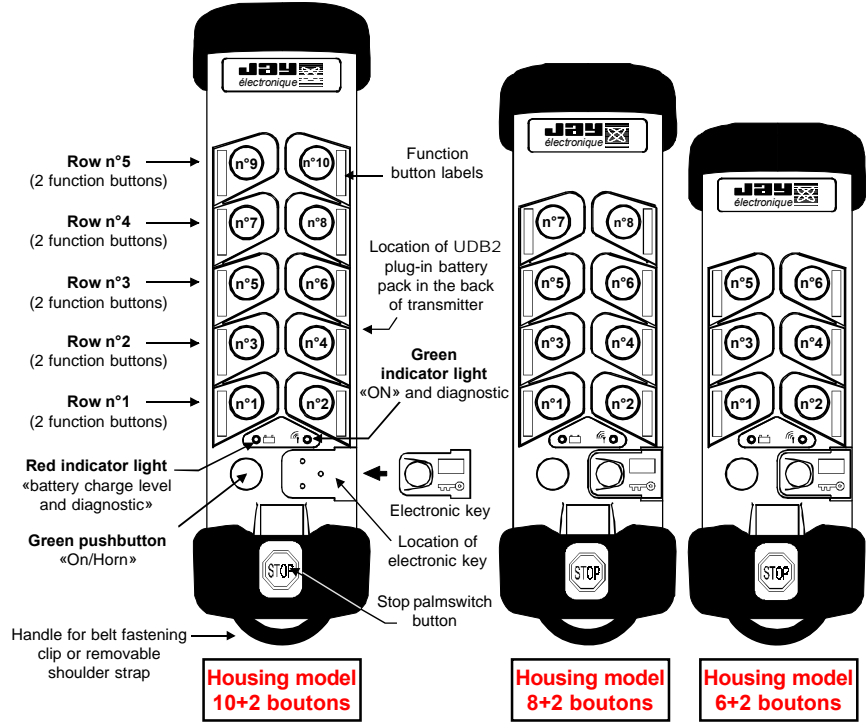

2.2 UDE transmitter function button labels

The various button functions are identified by means of adhesive labels placed in the recesses provided in the transmitter unit housing at each button location. The labels are supplied in the form of sheets with the various labels you will need for your application. Simply choose the labels corresponding to your configuration.

Reference : *
UWE202
Kit of 6 colored labels, «movements», for double speed pushbuttons (2 steps)

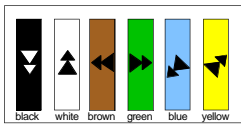

Reference : *
UWE207
Kit of 90 b/w labels «movements, special and customization functions» for pushbuttons and switches

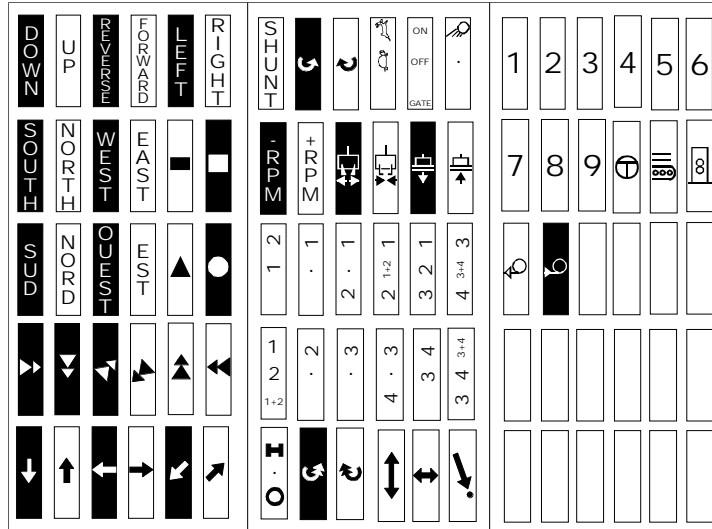

Reference :
UWE205
Kit of 48 white blank labels, «customization» + 48 transparent protecting labels.

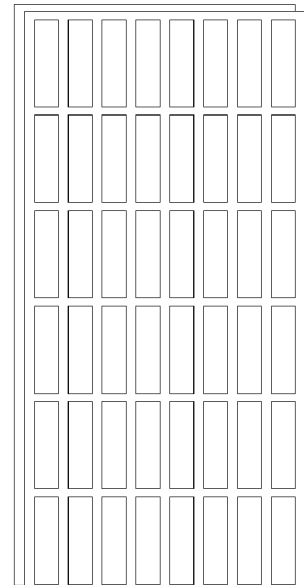

* = Label sheets provided as standard supply with UDE transmitter

2.3 Receiver UDR

Receivers are formed by a basic board on which the following components can be connected :

- 1 to 3 boards with 6 control relays
- 1 auxiliary board for additional function (options - see next page)
- 1 RS232 serial link board for diagnostic and programming purposes (option and accessory)

The basic board systematically comprises :

- **1 «Horn» relay**
(active when the transmitter «On/Horn» button is pressed, not auto-maintained)
- **2 safety relays**
(active when the transmitter «On/Horn» button is pressed, auto-maintained until passive or active stop)
- **3 terminal strips for UDF IR modules (option)**

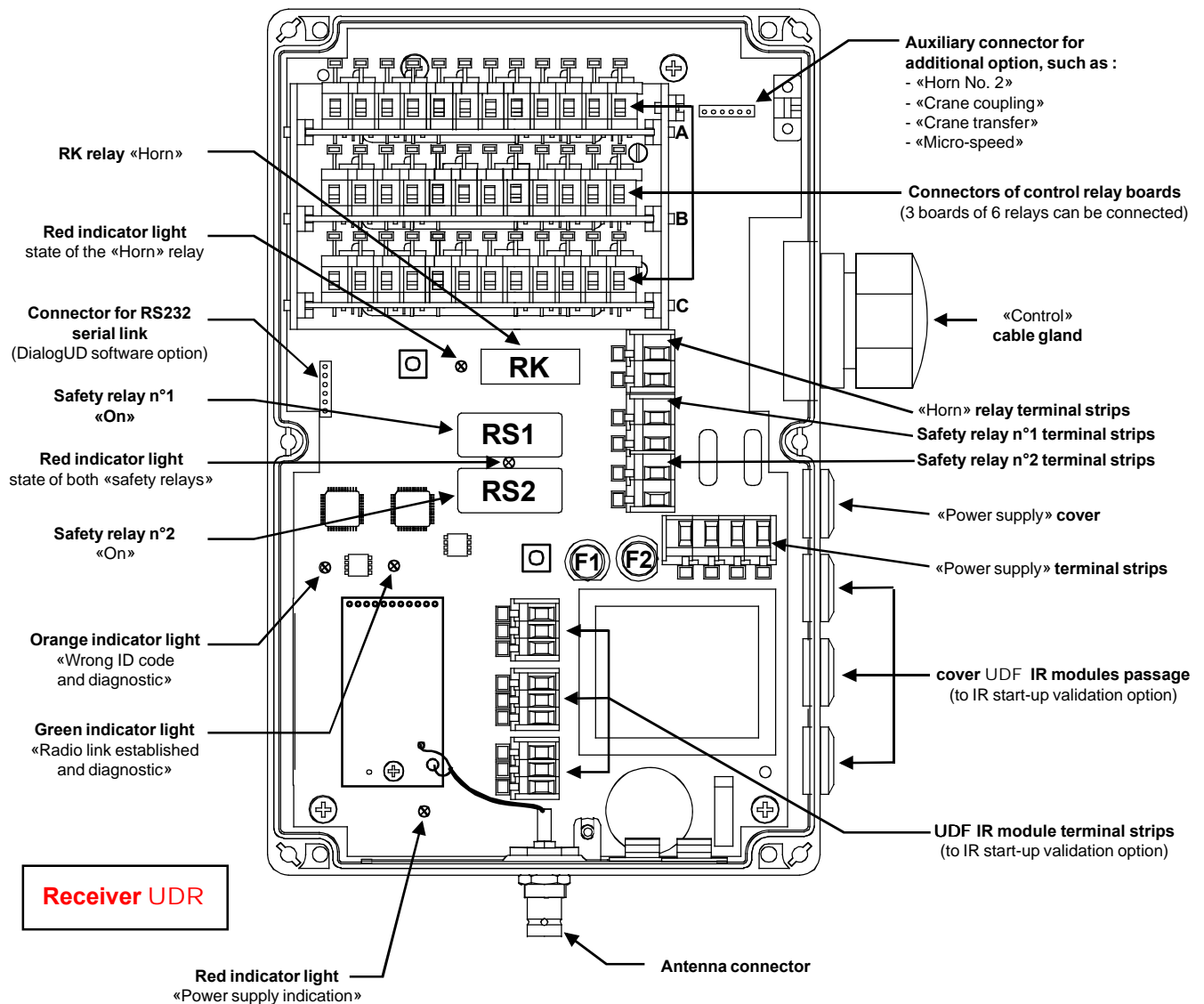

3- Additional options

“Horn n°2” option

The «Horn No. 2» option adds an auxiliary board to the UDR receiver. This board is equipped with a relay "RK2" which is activated when the "On/Horn" pushbutton is pressed on the UDE transmitter. It acts in the same way as the "RK" relay on the receiver motherboard and can be used to supply a device indicating startup of the equipment controlled (horn, rotating light, etc.).

Example of product configuration:

The «Horn No. 2» option requires installation of an auxiliary board in the receiver.

Transmitter reference: UDE..... - ...

Receiver reference: UDR...02 - ...

"IR start-up validation" option

Safety feature requiring IR validation to start up a remote controlled equipment can be used.

- To start the unit, the operator is required to point the transmitter toward the IR module installed on the equipment to be controlled (see positioning below). This ensures an error-free match-up between the transmitter and the equipment to be controlled.
- The IR start-up field of action has a range of 0 to 25 m (see Fig. A).
- 3 IR modules can be connected to the **UDR** receiver.

IMPORTANT : the wiring of the UDF IR module(s) must be separate from the power cables and all other sources which may generate interference (power regulator, for example).

UDF IR modules position:

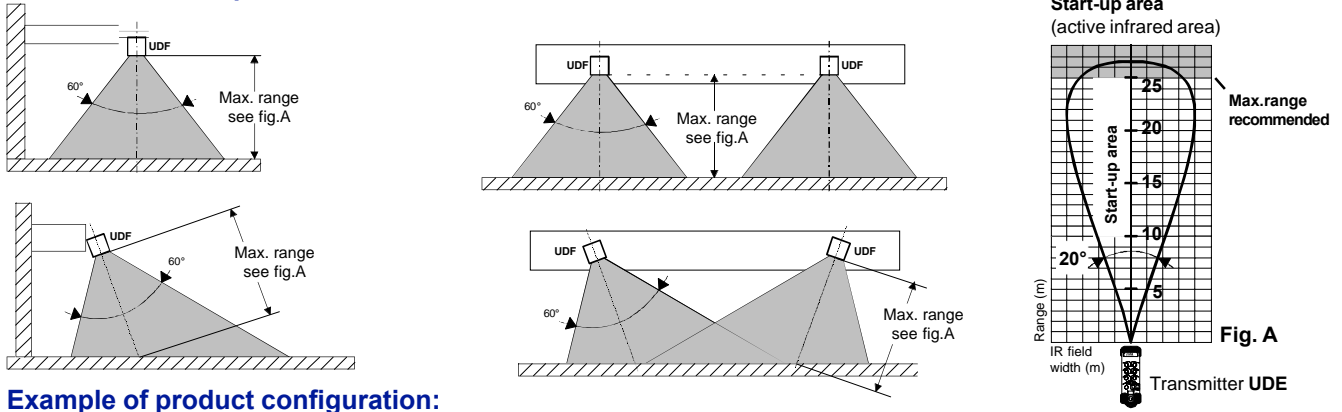

Example of product configuration:

The "IR start-up validation" option requires a transmitter equipped with this option, a receiver programmed for this option and at least one IR module.

- Transmitter reference: **UDE1..... - ...** or **UDE3..... - ...**
- Receiver reference: **UDR1...0 - ...** or **UDR1...02 - ...** or **UDR1...04 - ...**
- Reference for **UDF** IR modules: **UDF1** (1 module) or **UDF2** (kit with 2 modules)

Note : This option can not be used with «Coupled travelling cranes» option or «Travelling crane transfer» option.

"Transmitter – Receiver association on start-up" option

This function allows the operator to select the receive(s) to be controlled.

During the start-up phase (transmitter switched on), an encoded infrared message is transmitted to the receiver(s) pointed to by the operator. This option thus enables several transmitters (with difference id code and frequency) to successively take control of the receiver(s). This is particularly useful when several receivers are implemented and you wish to operate any receiver with any transmitter with no mutual interference. This feature also allows you to select two receivers with one transmitter and have them operate simultaneously. The infrared aiming characteristics are the same as those of the "start-up by infrared validation" option

Product configuration example:

The "transmission – receiver association on start-up" option requires a transmitter equipped with the option, a receiver programmed for the option and one or multiple **UDF** IR modules.

- Transmitter reference: **UDE1..... - ..6** or **UDE3..... - ..6** or **UDE5..... - ..6**
- Receiver reference: **UDR1...06 - ...**
- Reference for **UDF** IR modules: **UDF1** (1 module) or **UDF2** (kit comprising 2 modules)

Note: This option is not possible using the "Travelling crane coupling" or "Travelling crane transfer" option.

"DialogUD software" option

DialogUD provides help to **UD** system users for configuration, diagnostics and operating status consultation.

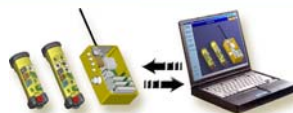

DialogUD provides the main remote intervention and remote maintenance functions:

- Programming of radio reception frequency.
- Programming of "transmitter button - receiver relay" assignments.
- Programming of control button electrical interlocking.
- Diagnostic function for management of preventive maintenance on equipment (receiver relay transition counter, combined relay activation time and possibility for saving all **UD** system information).
- Display of UDE transmitter operation to validate possible configuration changes.
- Display of receiver radio quality rate to diagnose possible zones of disturbances.

Example of product configuration:

The "DialogUD" option requires installation of an RS232 communication board in the receiver.

- Transmitter reference: **UDE..... - ...**
- Receiver reference: **UDR...0 - ...** + **UDWR32** serial link board
- «DialogUD» software reference: **UDWR36**

Hardware configuration required : PC486 DX4 100 MHz min, 32 MØ RAM, 1 serial port.
Software configuration required : Windows® 95/98/ME/NT4/2000/XP (registered trademark of Microsoft Corporation - USA).

"Micro-speed" option

- The **"Micro-speed"** option enables use of a second "button-relay" assignment register for the receiver, and control of an auxiliary relay.
- By a simple operation on the transmitter (pushbuttons Nos. 1 and 2 pressed for 3 seconds), a command is applied to the receiver to use another "button-relay" assignment table.
- The receiver is equipped with an auxiliary board on which a relay is activated when this function is used.
- To deactivate the **"Micro-speed"** function, the user must press transmitter pushbuttons n°1 and n°2 during 3 seconds a second time, so that the receiver returns to its normal state of use (the auxiliary relay is deactivated, and the receiver uses the first 'button-relay' assignment table)

Example of product configuration:

The **"Micro-speed"** option requires a transmitter which is programmed and equipped with pushbuttons at position Nos. 1 and 2, and a receiver programmed for this option.

Besides, a customization data sheet must be filled in to determine the button-relay actions in **"Micro-speed"** mode.

Transmitter reference: UDE•1•••• - ••4 or UDE•2•••• - ••4

Receiver reference: UDR••04 - 1••

"Coupled travelling cranes" option, "Tandem lift" type

- The **«coupled travelling cranes»** option allows a user to control 2 receivers simultaneously.
- The user also has the possibility of controlling 2 receivers independently thanks to a rotary or an electronic switch with 3 positions on one of both transmitters.
- With this process, it is also possible that 2 operators control these same receivers but separately, and simultaneously.
- The receiver (B) is equipped with an auxiliary board. A relay on the board indicates receiver availability.

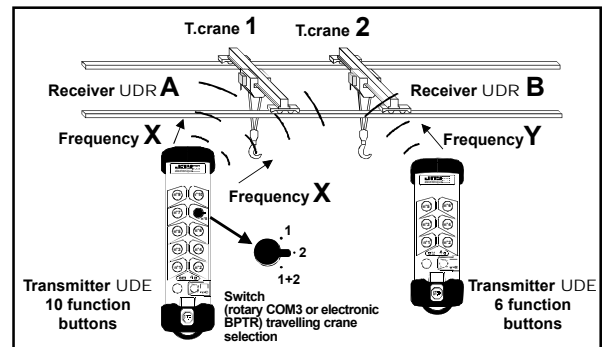

Example of product configuration:

The **"Coupled travelling cranes"** function requires 2 receivers and 2 transmitters.

● UDE transmitter with 10 function buttons:

This transmitter must be equipped with a selector switch (for operation with crane coupled or separate) and pushbuttons at position Nos. 3 and 4 (for "release" function).

Reference of UDE (rotary switch): UDE0•1•4• - ••3 or UDE0•2•4• - ••3
 Reference of UDE (electronic switch): UDE0•1•D• - ••3 or UDE0•2•D• - ••3

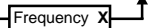

● UDE transmitter with 6 function buttons:

The transmitter is a standard transmitter and must have pushbuttons at position Nos. 3 and 4 (for "release" function).

Reference of this UDE: UDE0•1••• - ••3 or UDE0•2••• - ••3

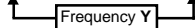

● Receiver UDR (A):

This receiver is standard, its reference is: UDR0••00 - 1•3

● Receiver UDR (B):

This receiver must be equipped with a **"Coupled T.crane"** auxiliary board and programmed in order to be controlled by two UDE transmitters. The sales reference of this receiver must be: UDR0••03 - 1•3

"Travelling crane transfer" option, "Pitch and catch" type

- The **"Travelling crane transfer"** option allows you to transfer control of a receiver from one user to another, each carrying a separate transmitter.
- This function enables you to control a device having a very long travel distance and/or crossing through different zones.
- The device cannot be controlled simultaneously by two users. When user No. 1 is controlling a device, he must first send a "release" command (transmitter pushbuttons Nos. 3 and 4 pressed for 3 seconds) to the receiver before user No. 2 can take control of the device.
- The receiver is equipped with an auxiliary board. A relay on the board indicates receiver availability.

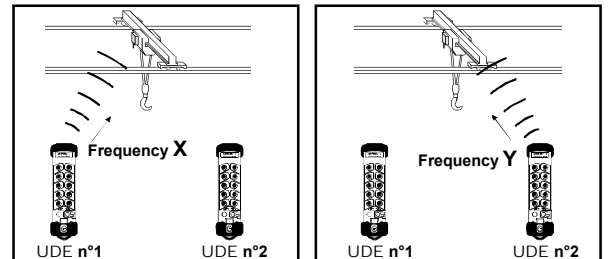

Equipment taken over by transmitter UDE No. 1

Once the equipment controlled is released by UDE transmitter No. 1, the second transmitter can take control.

Example of product configuration:

The **"Travelling crane transfer"** option requires two transmitters (which must have pushbuttons at position Nos. 3 and 4, and a receiver programmed for this function).

Transmitter UDE n°1 reference: UDE0•1••• - ••5 or UDE0•2••• - ••5

Transmitter UDE n°2 reference: UDE0•1••• - ••5 or UDE0•2••• - ••5

Receiver UDR reference: UDR••05 - 1••

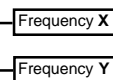

4- Safety aspects

The UD remote controls implement numerous safety features, in particular:

Transmitter / receiver communication safety features:

- Permanent radio link : by its non-directional design and insensitivity to the presence of obstacles, the operator is protected from exposure to handling risks during precision manoeuvres and movements.
- Each transmitter+receiver pair has its own specific identity code.
- Hamming distance (minimum number of bits that differ between 2 messages that are different) of 4.

Transmitter safety features:

- An active priority general shutdown command is generated when the «stop palmswitch button» is pressed.
- An electronic key limits access to the system to authorised persons only.
- An indicator light indicates an alarm in the event of an insufficiently charged battery.
- A «dead man» function shuts down the transmitter after a pre-programmed time period (1 to 98 mn or 1 to 99s) when no controls have been generated.
This function can be disabled at any time to meet specific needs.
- Buttons protected mechanically against unintentional actions.

Functional safety features:

- Start-up sequences are implemented to ensure safe operation by a trained, experienced operator.
- 55 ms response time compatible with the movement speeds of equipment controlled.

Receiver safety features:

- A passive shutdown device shuts down the system if the radio link is jammed.
- Category 3 safety per EN 954-1 is ensured by redundant control of the emergency stop circuit and use of guided contact safety relays.
- Contradictory commands can be interlocked electrically.

5- Compatibility

Compatibility between our UD, UR and XD Series

A transmitter UDE can be operated with a receiver URR of our UR series (see sales brochure E730) or with a receiver XDR^(*) of our XD series (see sales brochure E810).

A transmitter URE of our UR series (see sales brochure E730) or a transmitter XDE^(*) of our XD series (see sales brochure E810) can be operated with a receiver UDR.



(*) = This utilization configuration implies that the transmitter or receiver of the UD or UR series is not located, under any circumstances, in an explosible atmosphere. Only the transmitter or receiver of the XD series (ATEX approved) can be used in this type of hazardous environment.

6- Radio frequencies

433-434MHz or 869Mhz, with adjacent intervals of 0,025 MHz

433-434 MHz bands

Channel N°	Frequency MHz
01	433,100
02	433,125
03	433,150
04	433,175
05	433,200
06	433,225
07	433,250
08	433,275
09	433,300
10	433,325
11	433,350
12	433,375
13	433,400
14	433,425
15	433,450
16	433,475

Channel N°	Frequency MHz
17	433,500
18	433,525
19	433,550
20	433,575 (1)
21	433,600
22	433,625 (1)
23	433,650
24	433,675 (1)
25	433,700
26	433,725 (1)
27	433,750
28	433,775 (1)
29	433,800 (2)
30	433,825 (1) (2)
31	433,850 (2)
32	433,875 (1) (2)

Channel N°	Frequency MHz
33	433,900 (2)
34	433,925 (1) (2)
35	433,950 (2)
36	433,975 (1) (2)
37	434,000 (2)
38	434,025 (1) (2)
39	434,050 (2)
40	434,075 (2)
41	434,100 (2)
42	434,125 (2)
43	434,150 (2)
44	434,175 (2)
45	434,200 (2)
46	434,225 (2)
47	434,250 (2)
48	434,275 (2)

Channel N°	Frequency MHz
49	434,300 (2)
50	434,325 (2)
51	434,350 (2)
52	434,375 (2)
53	434,400 (2)
54	434,425 (2)
55	434,450 (2)
56	434,475 (2)
57	434,500 (2)
58	434,525 (2)
59	434,550 (2)
60	434,575 (2)
61	434,600 (2)
62	434,625 (2)
63	434,650 (2)
64	434,675 (2)

869 MHz band







Channel N°	Frequency MHz
01	869,9875
02	869,9625
03	869,9375
04	869,9125
05	869,8875
06	869,8625
07	869,8375
08	869,8125
09	869,7875
10	869,7625
11	869,7375
12	869,7125

(1)= List of frequencies available for Denmark

(2)= List of frequencies available for Singapore

7- Technical characteristics

7.1 Transmitter UDE

Mechanical and environment withstand characteristics
Housing: ABS Choc, yellow - IP65 - Mechanical button protection
Weight (with battery pack): 6 function buttons: 400 g 8 function buttons: 450 g 10 function buttons: 490 g
Dimensions (without protective foams): 6 function buttons: 70x53x220 mm 8 function buttons: 70x53x245 mm 10 function buttons: 70x53x276 mm
Operating temperature range: -20°C to +50°C
Storage temperature range (without battery pack): -30°C to +70°C
Storage temperature range (with battery pack): -30°C to +35°C
Attachment when idle: Wall (by anse d'accrochage) or belt (by clip d'accrochage)
Electrical and radio characteristics
Power supply: Plug-in NiMH battery
Endurance transmit time/buttons typical average use (at +25°C): Frequency 433-434MHz bands: 24 hours / 50% transmit time Frequency 869MHz band: 20 hours / 50% transmit time
Frequency: 64 user-programmable in 433-434MHz bands (see list on page 6) 12 user-programmable in 869MHz band (see list on page 6)
Transmit power: <10 mW (license not required) built-in antenna
Modulation: FM
Average range with VUB084 antenna on UDR receiver (1): 100m in typical industrial environment 300m in unobstructed area
Functionnal characteristics
Functions: 6 differents kinds of fonctions buttons: - One-step pushbutton (single speed) " BPSV "  - Two-step pushbuttons (double speed) " BPDV "  - Rotary switch with 2 fixed positions " COM2 "  - Rotary switch with 3 fixed positions " COM3 "  - Rotary switch with 3 positions with auto. return " COM3R "  - Electronic switch with 3 fixed positions " BPTR "  1 pushbutton "On/Horn" 1 active priority emergency stop palmswitch 1 electronic key
Dead man function: Time is user-programmable
Indicator lights: 1 red "battery level" and diagnostic indicator light 1 green diagnostic indicator light

7.2 Battery pack UDB2

Mechanical, functional and environmental characteristics
Housing: ABS Choc, yellow - IP40
Dimensions: 40x96x23 mm
Storage temperature range: -30°C to +35°C
Slow charging time: 0°C to +45°C
Complete slow charging time: 14 heures
Indicator lights Charging: 1 red light indicator on battery pack Charge status: 1 red light indicator on transmitter (battery low)
Power supply protection - by charger UBCU or UBCV - by connector UBC1 (10 à 30 VDC)

7.3 Receiver UDR

Mechanical and environment withstand characteristics
Housing: ABS, grey, IP65
Weight: 2 kg (approx.)
Dimensions : 160x250x120 mm (not including antenna and cable gland)
Operating temperature range: -20°C to +50°C
Storage temperature range: -30°C to +70°C
Cable lead-outs Control outputs: 1 plastic cable gland M32 (Ø 20 to 26 mm cables) IR modules: 3 cover M16 (Ø 5 to 7 mm cables) (2) Power supply: 1 cover M16 (Ø 5 à 7 mm cables) (2)
Connection: Spring-type terminal strips for 0.08² to 2.5² section wires
Radio characteristics
<i>Characteristics complying with ETS 300 220</i>
Frequency 64 user-programmable in 433-434MHz bands (see list on page 6) 12 user-programmable in 869 MHz band (see list page 6)
Antenna VUB084 antenna, supplied with receiver (1/4 wave in 433-434MHz, 1/2 wave in 869MHz, plug-in BNC plug)
Sensitivity < -100dBm
Electrical characteristics
Power supply and consumption (3) (with 2 safety relays, 8 function relays pulled in, and 3 UDF modules connected to receiver) Version DC 12VDC, 0 to +25%, 675mA and 188mA when idle 24VDC, -15% to +20%, 675mA and 188mA when idle Version AC n°1 24VAC, -15% to +10%, 850mA 48VAC, -15% to +10%, 400mA Version AC n°2 115VAC, -15% to +10%, 180mA 230VAC, -15% to +10%, 85mA
Control: 1 "horn" relay + 6, 12 or 18 function relays
Safety: 2 relays with linked and guided contacts
Outputs: Independent 1 NO relay - Category DC13 0,5A / 24VDC , AC15 2A / 230VAC - Max. breaking capacity 2000VA - Max. current 8A (control relay), 6A (safety relay) - Min. current 10 mA (12 Vmin.) - Max. voltage 250VAC - Service life with 230VAC, 70VA, cosphi=0,75 : 3x106 cycles
Response time: - On start-up: 0,5s max. - On control: 55 ms max.
Active shutdown time: 145 ms max.
Passive shutdown time: 1,1 s max.
Indicator lights: - 1 red "power on" indicator light - 1 red indicator light + 1 green diagnostic indicator light - 1 red status indicator light per relay
Power supply protections: - Against polarity inversions for DC versions - Against overcurrents by fuse

(1)= Range will vary according to environment conditions of transmitter and reception antenna (metal frameworks, walls ...).

(2)= Covers can be replaced by M16 plastic cable glands to be mounted at the same place. M16 plastic cable glands are systematically delivered with UDF IR Modules.

(3)= The number of function relays controlled simultaneously is limited to 10 relays with 1 UDF module connected to UDR receiver, or to 9 relays with 2 UDF modules connected, or to 8 relays with 3 UDF modules connected.

8- Dimensions

8.1 Transmitter UDE

(6+2, 8+2 and 10+2 button versions)

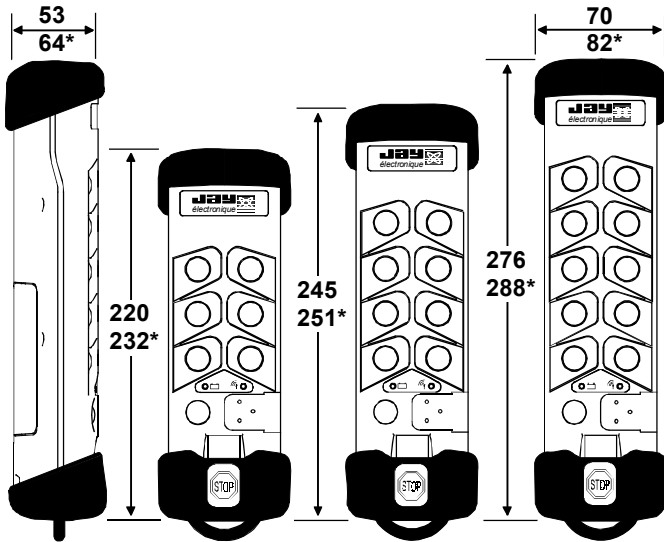

*= dimensions with protective foams

8.2 IR module UDF

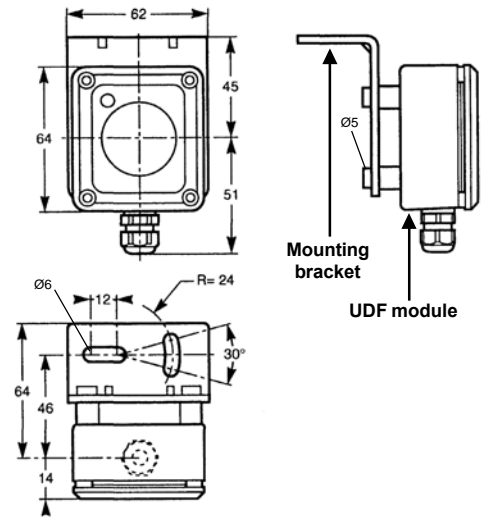

8.3 Receiver UDR

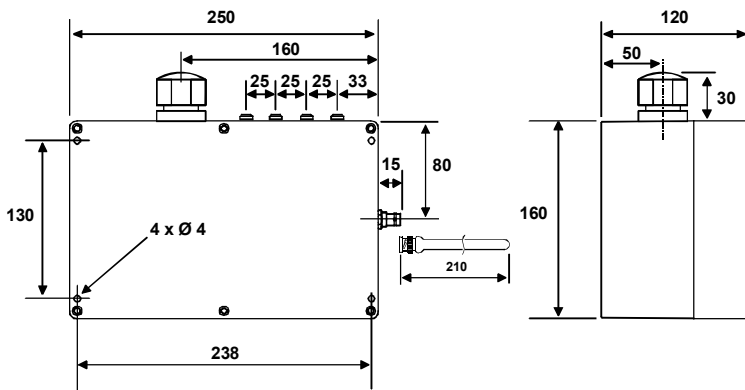

8.4 Chargers and connector UBC•

(to recharge battery pack UDB2)

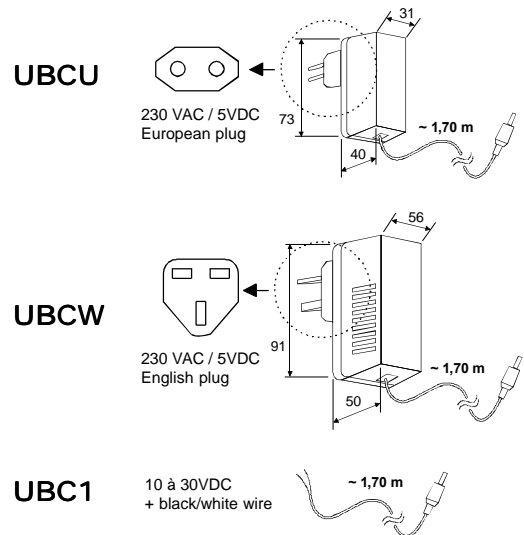

8.5 Wall Bracket UDC1

to charger
or connector
UBC•

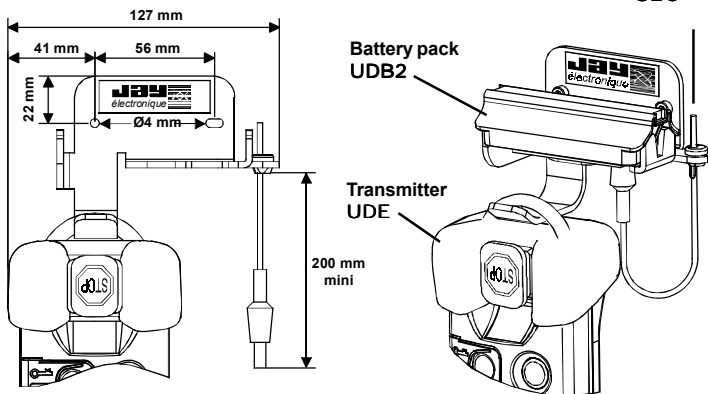

8.6 Battery pack UDB2

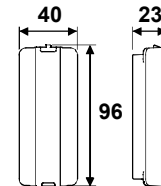

8.7 Antennas VUB08•

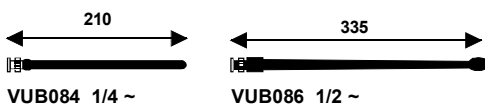

8.8 Self-adhesive arrows UWE00•

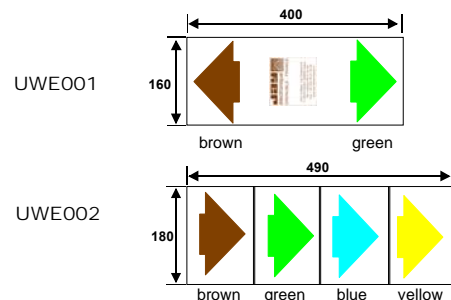

9- Selection guide, references for ordering

9.1 Standard unit selection guide

(transmitter + receiver + charger - radio channel nb.01 - 433-434MHz bands)

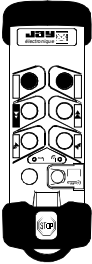
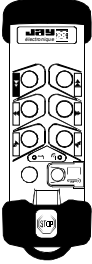
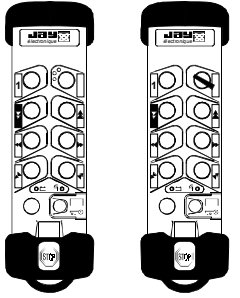
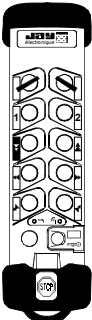
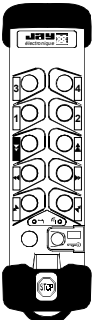
Applications	Transmitter front view	Transmitter configurations	Receiver configurations	Assembly references
Monorails Jib cranes		4 two-step pushbutton (double speed) + 1 bouton "On/Horn" button + 1 emergency stop palmswitch	3 + 6 relays	UD00A①②③④ + complementary ref.: ④ ⑤ ⑥
Travelling cranes Gantry cranes		6 two-step pushbutton (double speed) + 1 bouton "On/Horn" button + 1 emergency stop palmswitch	3 + 12 relays	UD11B①②③④ + complementary ref.: ④ ⑤ ⑥
Travelling cranes Gantry cranes	 Version avec commutateur électronique Version avec commutateur rotatif	6 two-step pushbutton (double speed) + 1 one-step pushbutton (single speed) + 1 1 rotary switch or electronic switch with 3 fixed positions + 1 "On/Horn" button + 1 emergency stop palmswitch	3 + 12 relays	With electronic switch: UD21B①②③④ + complementary ref.: ④ ⑤ ⑥
				With rotary switch: UD22B①②③④ + complementary ref.: ④ ⑤ ⑥
Travelling cranes Gantry cranes		6 two-step pushbutton (double speed) + 2 one-step pushbutton (single speed) + 1 rotary switch with 2 fixed positions + 1 rotary switch with 3 fixed positions + 1 "On/Horn" button + 1 emergency stop palmswitch	3 + 18 relays	UD33C①②③④ + complementary ref.: ④ ⑤ ⑥
Travelling cranes Gantry cranes		10 two-step pushbutton (double speed) + 1 "On/Horn" button + 1 emergency stop palmswitch	3 + 18 relays	UD31C①②③④ + complementary ref.: ④ ⑤ ⑥

A standard unit comprises:

- 1 transmitter with 1 battery pack
+ 1 electronic key + 2 label sheets (UWE202+UWE207)
- 1 additional battery pack
- 1 receiver with 1 antenna **VUB084**
+ 1 1 wiring accessory for common line
- 1 charger (for battery pack)
- 1 installation and user manual
- 0, 1 or 2 **UDF** IR modules (according to reference)

① Receiver power supply:

4: 12 - 24 VDC
 A: 24 - 48 VAC
 B: 115 - 230 VAC

② IR Start-up validation option:

0: no
 1: yes, with 2 **UDF** IR modules
 E: yes, with 1 **UDF** IR module

③ Type of charger for battery pack charging:

0: **UBCU** charger (230VAC/12VDC-european plug)
 2: **UBCW** charger (230VAC/12VDC-english plug)

④ Programming of interlocking: see § 9.2 (receiver complement)

⑤ Programming of two-step pushbutton (double speed) (BPDV): see § 9.2 (receiver complement)

⑥ Programming of rotary switch with 3 fixed positions or electronic switch with 3 fixed positions (COM3/BPTR): see § 9.2 (receiver complement)

9.1.1 Wiring diagram for standard units

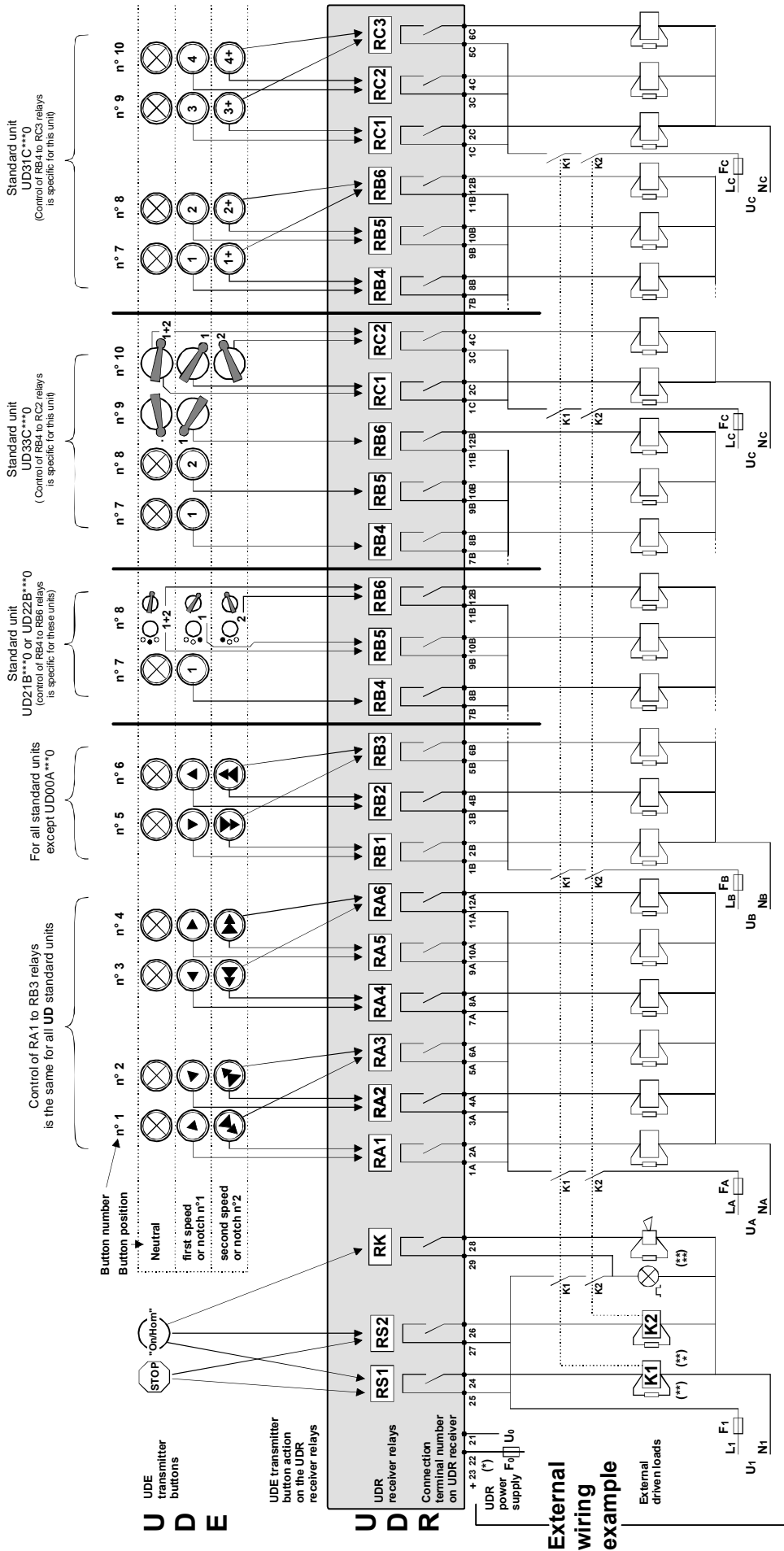

(*)=The power supply connection depends on the type of receiver and the power supply required. (terminals 23-21] for power supplies 12VDC, 24VAC, 115VAC of 23-21] for power supplies 24VDC, 48VAC, 230VAC)

(**)= Relay life is increased by the use of surge limiters (ex.RC network for AC, Zener + diodes for DC, etc...)

(***)= K1 and K2 contactors must have guided contacts

(****)= Elements which indicate start of remote controlled machines (ex.: horn, rotating/flashing light, etc...)

Safety relays RS1 and RS2 are switched on by the pushbutton "On/Horn", and hold in position until the emergency stop palms switch is pressed (active shutdown) or until the loss of the radio transmission (passive shutdown).

9.2 Selection guide for separate elements (transmitter / receiver / accessories)

Transmitter UDE

Diagram illustrating the selection guide for the Transmitter UDE, showing the model code structure and associated options.

Model Code Structure: UDE [] [] [] [] [] [] - [] [] []

Type of function buttons (2) on first row (starting from bottom of transmitter): U, D, E

Type of function buttons (2) on second row: [] []

Type of function buttons (2) on third row: [] []

8+2 or 10+2 button version: Type of function buttons (2) on fourth row
or
Version 6+2 buttons: write 0 (zero)

Type of marking labels on buttons or additional function:
 1 = standard, without additional function
 3 = "coupled travelling cranes" option "tandem lift" type
 4 = "micro-speed" option
 5 = "travelling crane transfer" option "pitch and catch" type
 6 = "Transmitter – Receiver association on start-up" option
 x = special (equipment definition covered by a customization data sheet)

Type of communication and version:
 0 = Radio, 433-434MHz bands
 1 = Radio, 433-434MHz bands + IR start-up option
 2 = Radio, 433-434MHz bands without electronic key (1)
 3 = Radio, 433-434MHz bands + IR start-up option and without electronic key (1)
 A = Radio, 869MHz band
 B = Radio, 869MHz band + IR start-up option
 C = Radio, 869MHz band without electronic key (1)
 D = Radio, 869MHz band + IR start-up option and without electronic key (1)

10+2 button version: Type of function buttons (2) on fifth row
or
8+2 button version: write 0 (zero)
ou6+2 button version: write 0 (zero)

Radio channel number (see page 6): [] [] []

(1)= Only for auxiliary transmitter

(2)= Types of function buttons per row:

1 = BPSV, BPSV		5 = COM2, COM2		9 = COM2, COM3R		D = BPSV, BPTR	
2 = BPDV, BPDV		6 = COM2, COM3		A = COM3, COM3R		E = COM2, BPTR	
3 = BPSV, COM2		7 = COM3, COM3		B = COM3R, COM3R		Contact us concerning programming restrictions due to the use of switches on row 1 and row 2.	
4 = BPSV, COM3		8 = BPSV, COM3R		C = Obturateur, Obturateur			

Exemple : UDE013600 - 011
 433-434MHz radio transmitter UDE 6+2 buttons, without IR start-up validation, with an electronic key, buttons configuration : first row BPSV- BPSV, second row BPSV-COM2, third row COM2-COM3, label kit ref:UWE204 is supplied with transmitter and the pre-programmed radio channel is 01 (433.1 MHz).

Receiver UDR

Diagram illustrating the selection guide for the Receiver UDR, showing the model code structure and associated options.

Model Code Structure: UDR [] [] [] [] [] [] - [] [] []

Power supply:
 4 = 12 - 24 VDC
 A = 24 - 48 VAC
 B = 115 - 230 VAC

Additional option:
 0 = standard
 2 = "Horn n°2"
 3 = "Coupled travelling cranes" "tandem lift" type
 4 = "micro-speed"
 5 = "Transfert de pont roulant" type "pitch and catch"
 6 = "travelling crane transfer"

Programming of button - relay correspondence:
Transmitter UDE button - Receiver UDR relay:
 Number of transmitter relays controlled by BPDV (double speed pushbutton)
 1 = 3 relays or no BPDV
 2 = 4 relays

Programming button - relay correspondence:
UDE transmitter relay - UDR receiver relay:
 Type of control for COM3, COM3R and BPTR (switches with 3 positions)
 1 = Type : 1/1+2/2 or no COM3/COM3R/BPTR
 2 = Type : 1/OFF/2
 3 = Type : 1/2/1+2

Type of communication and version:
 0 = Radio, 433-434MHz bands
 1 = Radio, 433-434MHz bands + IR start-up option (4)
 A = Radio, 869MHz band
 B = Radio, 869MHz band + IR start-up option (4)

Number of outputs:
 A = 3(3) + 6 relays
 B = 3(3) + 12 relays
 C = 3(3) + 18 relays

Programming of interlocking between pushbutton: (BPSV or BPDV type) n°1-n°2, n°3-n°4, et n°5-n°6 :
 0 = no interlocking or COM on each row
 1 = interlocking with output relays set to OFF
 2 = interlocking with priority on left button (n°1, n°3 and n°5 buttons)
 3 = interlocking with priority on right button (n°2, n°4 and n°6 buttons)

(3)= 2 safety relays + 1 «On/Horn» relay
 (4)= This only includes the required programming for the receiver. The UDF IR modules must be ordered separately.

Exemple : UDR0BB00 - 112
 433-434Mhz radio receiver UDR, without IR start-up validation, 3+12 relays, power supply: 115-230VAC, without serial link option, without programmed interlocking, without BPDV on transmitter, COM3 of the transmitter are: 1/OFF/2.

Accessories for UDE transmitter

Reference	Description
UBCU	Charger 230VAC (european plug)/12VDC (for UDB2 battery pack charging)
UBCW	Charger 230VAC(english plug)/12VDC (for UDB2 battery pack charging)
UBC1	Battery connector (10 to 30VDC max.) (for UDB2 battery pack charging)
UDB2	Plug-in battery pack (1)
UDC1	Wall bracket for stowing and battery pack charging when idle
UDWE22 X	Programmed electronic key (parameters to be supplied) (1)
UDP1	Belt fastening clip
UWE102	Removable shoulder strap
UWE301	Protective case for transmitter 6+2 button version
UWE302	Protective case for transmitter 8+2 button version
UWE303	Protective case for transmitter 10+2 button version
UWE202	Kit of 6 colored labels "movements" for two-step pushbuttons (double speed) (1)
UWE205	Kit of 48 white blank labels for customized marking
UWE207	Kit of 90 b/w labels "movements, special and customization functions" for pushbuttons and switches (1)

Accessories for UDR receiver

Reference	Description
VUB084	BNC, 1/4 wave straight antenna (1)
VUB086	BNC, 1/2 wave straight antenna
VUB170	0,5 m extension for BNC antenna + non insulated bracket
VUB105	2 m extension for BNC antenna + non insulated bracket
VUB125	5 m extension for BNC antenna + non insulated bracket
VUB131	10 m extension for BNC antenna + non insulated bracket
UWE001	2 ways directional arrows to travelling cranes
UWE002	4 ways directional arrows to travelling cranes (1)
UDWR38	Fastening Kit for receivers by magnetic contacts
UDWR12	Common wiring accessory (1)
UDWR13	24-pin plug-in connector + 2m cable
UDWR14	16-pin plug-in connector + 2m cable
UDWR23	UDWR13 cabling realization in UDR receiver
UDWR24	UDWR14 cabling realization in UDR receiver
UDF1	1 UDF IR module (10m cable and cable gland included) for IR start-up validation option
UDF2	2 UDF IR modules (10m cable and cable gland included) for IR start-up validation option
UDWR10	10m cable extension for UDF IR modules
UDWR32	Serial link board
UDWR36	"DialogUD" software (CD-ROM + PC/UDR cable)

(1)= 1 accessory supplied with product

The products presented in this document are subject to change. Product descriptions and characteristics are not contractually binding.
Please go to our internet site www.jay-electronique.fr to download the most recent updates to our documentation.

E330 E - 0807



ZAC la Bâtie, rue Champrond
F38334 SAINT ISMIER cedex
☎ +33 (0)4 76 41 44 00 - 📠 +33 (0)4 76 41 44 44
www.jay-electronique.fr

ELEKTRO-TRADING sp. z o.o.
Tel. +48 (0-32) 734-55-72
Tel/Fax +48 (0-32) 734-55-70
E-Mail et@elektro-trading.com.pl
<http://www.elektro-trading.com.pl>