

D.C. direct drive brushed motors

→ Ø 32 mm 3.9 Watts

- A range of small D.C. direct-drive brushed motors with a case diameter of 32 mm and 3.9 Watts output power. Available in either 12 or 24 V D.C. versions.
- Sintered bronze bearings lubricated for life.
- Connection by 2.8 mm push-on terminals.
- Interference suppression fitted as standard.



Specifications

	3.9 Watts	3.9 Watts with encoder 1 pulse/revolution	3.9 Watts	3.9 Watts with encoder 1 pulse/revolution
Type	82 860 0	82 860 0	82 860 0	82 860 0
Voltage	12 V	12 V	24 V	24 V
Part numbers	82 860 003	82 860 501	82 860 004	82 860 502
No-load characteristics				
Speed of rotation (rpm)	5000	5000	5000	5000
Absorbed power (W)	1.2	1.2	1.92	1.92
Absorbed current (A)	0.1	0.1	0.08	0.08
Nominal characteristics				
Speed (rpm)	3700	3700	3700	3700
Torque (mN.m)	7.7	7.7	7.7	7.7
Usable power (W)	3	3	3	3
Absorbed power (W)	6.2	6.2	6	6
Absorbed current (A)	0.43	0.43	0.26	0.26
Gearbox case temperature rise (°C)	50	50	50	50
Efficiency (%)	48	48	50	50
General characteristics				
Insulation class (conforming to IEC 85)	B (130 °C)	B (130 °C)	B (130 °C)	B (130 °C)
Protection rating	IP40	IP40	IP40	IP40
Max. output (W)	3.9	3.9	3.9	3.9
Start torque (mN.m)	30	30	30	30
Starting current (A)	1.5	1.5	0.76	0.76
Resistance (Ω)	8	8	32	32
Inductance (mH)	10	10	41.6	41.6
Torque constant (Nm/A)	0.0214	0.0214	0.0448	0.0448
Electrical time constant (ms)	1.3	1.3	1.3	1.3
Mechanical time constant (ms)	36	36	36	36
Thermal time constant (min)	8	8	8	8
Inertia (g.cm ²)	19	19	19	19
Weight (g)	96	96	95	95
No of segments	3	3	3	3
Service life (h)	3000	3000	3000	3000
Sintered bronze bearings	✓	✓	✓	✓

Product adaptations

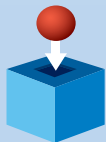

- Special output shafts
- Pinion or bush on output shaft
- Special supply voltages
- Special cable lengths
- Special output bearings
- Optional encoder
- Special mounting plate
- Customised electronics
- Special connectors

To order, see page 13

Curves

A - Nominal speed and torque curves
 B - Torque/Current curves

82 860 0

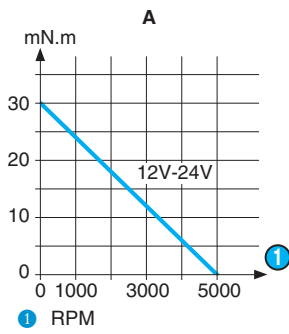

82 860 0

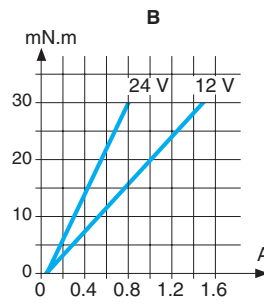

Dimensions

82 860 0

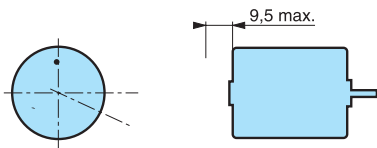

- ① 2 tags NFC 20 - 120 series 2.8 x 0.5 mm
- ② 3 holes at 120° on Ø 26 mm : use self tapping screws M2.2 ; screw depth max 6 mm

D.C. direct drive brushed motors

→ Ø 42 mm 10 to 17 Watts

- A range of D.C. direct-drive brushed motors with a case diameter of 42 mm and 10 to 17 W output power. Available in either 12, 24 or 48V D.C. versions
- Sintered bronze bearings lubricated for life
- Supply connection by 4.75 mm tags
- Replaceable brushes
- Optional magnetic encoder



Specifications

	10 Watts	10 Watts	17 Watts	17 Watts
Type	82 810 0	82 810 0	82 800 0	82 800 0
Voltage	12 V	24 V	12 V	24 V
Part numbers	82 810 017	82 810 018	82 800 036	82 800 037
No-load characteristics				
Speed of rotation (rpm)	2850	2780	2960	2750
Absorbed power (W)	4.8	4.3	4.8	4.3
Absorbed current (A)	0.4	0.18	0.4	0.18
Nominal characteristics				
Speed (rpm)	2000	2000	2000	2000
Torque (mN.m)	45	41.5	75	75
Usable power (W)	9.4	8.7	15.7	15.6
Absorbed power (W)	20.4	15.6	30	26.4
Absorbed current (A)	1.7	0.65	2.5	1.1
Gearbox case temperature rise (°C)	45	46	44	40
Efficiency (%)	46	55.7	52	59
General characteristics				
Insulation class (conforming to IEC 85)	F (155 °C)	F (155 °C)	F (155 °C)	F (155 °C)
Protection (IEC 529) Housing	IP20	IP20	IP20	IP20
Max. output (W)	10.3	9.5	16.3	17
Start torque (mN.m)	127	117	185	210
Starting current (A)	4	1.7	5.8	2.7
Resistance (Ω)	3.1	14.6	2	7.7
Inductance (mH)	2.5	10.7	1.8	6.9
Torque constant (Nm/A)	0.035	0.077	0.0342	0.0724
Electrical time constant (ms)	0.8	0.73	0.89	0.89
Mechanical time constant (ms)	19	17	18	16
Thermal time constant (min)	10	10	12	12
Inertia (g.cm ²)	80	72	105	110
Weight (g)	310	310	400	400
No of segments	8	8	8	8
Service life (h)	3000	3000	3000	3000
Sintered bronze bearings	✓	✓	✓	✓
Replaceable brushes (mm)	✓	✓	✓	✓

Product adaptations

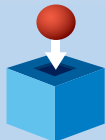

- Special output shafts
- Pinion or bush on output shaft
- Special supply voltages
- Special cable lengths
- Special output bearings
- Optional encoder
- Special mounting plate
- Customised electronics
- Special connectors

Curves

A - Torque/Speed curves
B - Torque/Current curves

82 810 0

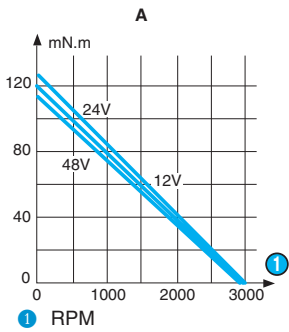

82 810 0

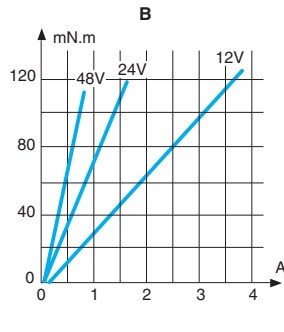

82 800 0

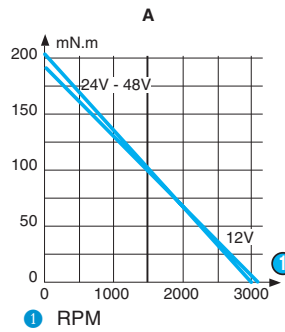

82 800 0

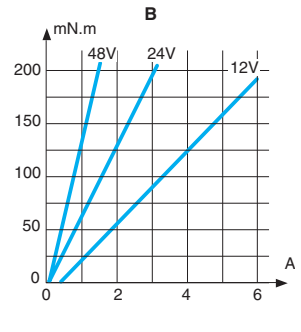

Dimensions

82 810 0

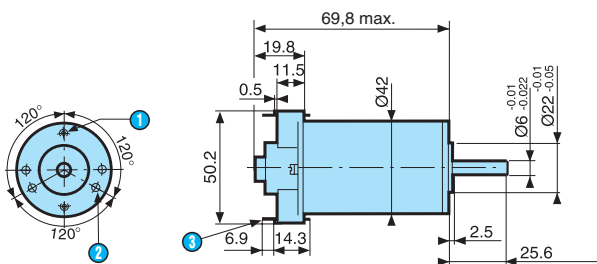

- ① 2 M3 at 180° depth 5 mm on Ø 32
- ② 2 holes x Ø 2.75 ± 0.05 at 120° C depth 5 mm Ø 32
- ③ 2 tags IEC 760 series 4.8 x 0.5 mm

82 800 0

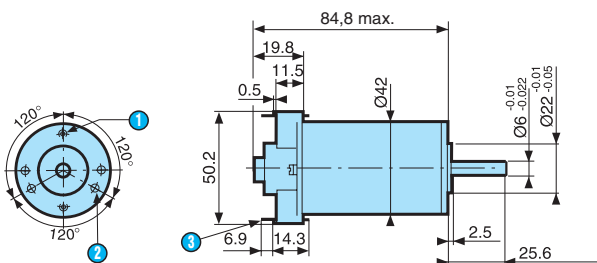

- ① 2 M3 at 180° depth 5 mm on Ø 32
- ② 2 x Ø 2.75 ± 0.05 at 120° depth 5 mm Ø 32
- ③ 2 tags IEC 760 series 4.8 x 0.5 mm

D.C. direct drive brushed motors

→ Ø 42 mm 14 to 31 Watts

- A range of small D.C. direct-drive brushed motors with a case diameter of 42 mm and between 14 and 31 W output power. Available in either 12 or 24 V D.C. versions.
- Sintered bronze bearings lubricated for life
- Replaceable brushes
- Magnetic encoder option



Specifications

	14 Watts	16 Watts	22 Watts	31 Watts
Type	82 810 5	82 810 5	82 800 5	82 800 5
Voltage	12 V	24 V	12 V	24 V
Part numbers	82 810 501	82 810 502	82 800 501	82 800 502
No-load characteristics				
Speed of rotation (rpm)	3840	3860	3920	4010
Absorbed power (W)	12	11.28	9.96	12.24
Absorbed current (A)	1	0.47	0.83	0.51
Nominal characteristics				
Speed (rpm)	2580	2750	2670	3070
Torque (mN.m)	45	45	70	70
Usable power (W)	12	13	20	22
Absorbed power (W)	31	32	37	41
Absorbed current (A)	2.6	1.32	3.05	1.71
Gearbox case temperature rise (°C)	32	33	38	40
Efficiency (%)	39	40.8	54	54
General characteristics				
Insulation class (conforming to IEC 85)	F (155 °C)	F (155 °C)	F (155 °C)	F (155 °C)
Protection (IEC 529) Housing	IP20	IP20	IP20	IP20
Max. output (W)	14	16	22	31
Start torque (mN.m)	138	156	219	298
Starting current (A)	6.2	3.4	9	6.16
Resistance (Ω)	1.94	7.06	1.33	3.9
Inductance (mH)	4.45	16.94	2.67	9.35
Torque constant (Nm/A)	0.0265	0.0532	0.0268	0.0527
Electrical time constant (ms)	2.3	2.4	2	2.4
Mechanical time constant (ms)	26	23	20	15
Thermal time constant (min)	8	8	12	12
Inertia (g.cm ²)	80	72	105	110
Weight (g)	310	310	400	400
No of segments	8	8	8	8
Service life (h)	2000	2000	2000	2000
Sintered bronze bearings	✓	✓	✓	✓
Replaceable brushes (mm)	✓	✓	✓	✓

Product adaptations

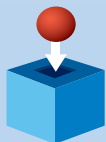

- Special output shafts
- Pinion or bush on output shaft
- Special supply voltages
- Special cable lengths
- Special output bearings
- Optional encoder
- Special mounting plate
- Customised electronics
- Special connectors

To order, see page 13

Curves

A - Torque/Speed curves
B - Torque/Current curves

82 810 5

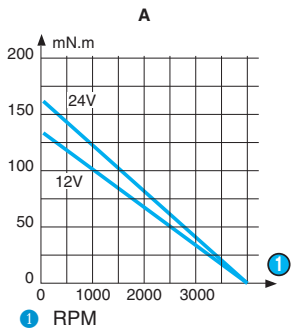

82 810 5

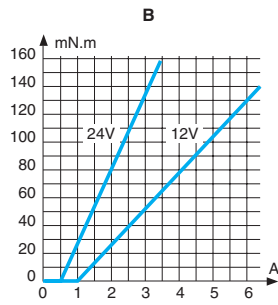

82 800 5

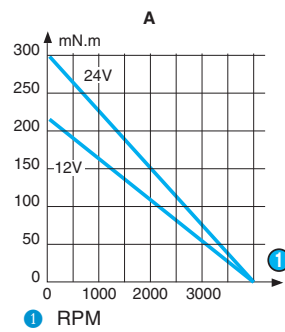

82 800 5

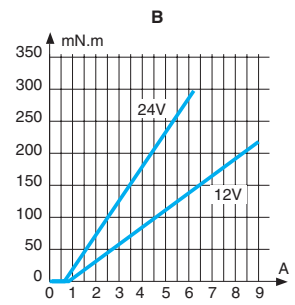

Dimensions

82 810 5

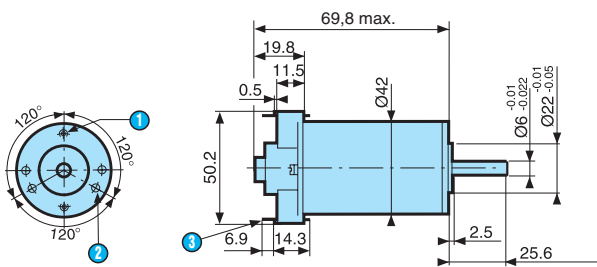

- ① 2 M3 at 180° depth 5 mm on Ø 32
- ② 2 x Ø 2.75 at 120° depth 5 mm on Ø 32
- ③ 2 tags IEC 760 series 4.8 x 0.5 mm

82 800 5

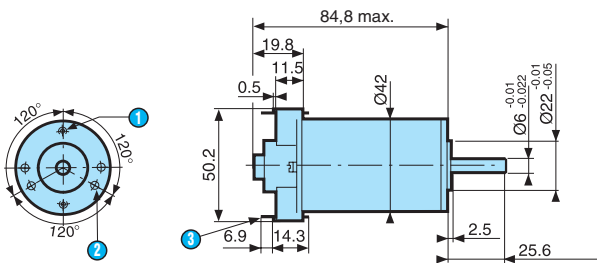

- ① 2 M3 at 180° depth 5 mm on Ø 32
- ② 2 x Ø 2.75 at 120° depth 5 mm on Ø 32
- ③ 2 tags IEC 760 series 4.8 x 0.5 mm

D.C. direct drive brushed motors

→ Ø 42 mm 22 to 52 Watts

- A range of small D.C. direct-drive brushed motors with a case diameter of 42 mm and between 22 and 52 Watts output power. Available in either 12 or 24 V D.C. versions.
- Sintered bronze bearings lubricated for life
- Supply connection by 2 leads



Specifications

	22 Watts	31 Watts	42 Watts	52 Watts
Type	82 800 8	82 800 8	82 850 0	82 850 0
Voltage	12 V	24 V	12 V	24 V
Part numbers	82 800 801	82 800 802	82 850 001	82 850 002
No-load characteristics				
Speed of rotation (rpm)	3920	4010	4150	4050
Absorbed power (W)	9.96	12.24	7.32	7.44
Absorbed current (A)	0.83	0.51	0.61	0.31
Nominal characteristics				
Speed (rpm)	2670	3070	3100	3200
Torque (mN.m)	70	70	100	100
Usable power (W)	20	22	32.5	33.5
Absorbed power (W)	37	41	51	52
Absorbed current (A)	3.05	1.71	4.25	2.15
Gearbox case temperature rise (°C)	38	40	63	54
Efficiency (%)	54	54	63	64
General characteristics				
Insulation class (conforming to IEC 85)	F (155 °C)	F (155 °C)	F (155 °C)	F (155 °C)
Protection (IEC 529) Terminal	IP20	IP20	IP20	IP20
Max. output (W)	22	31	42	52
Start torque (mN.m)	219	298	390	490
Starting current (A)	9	6.16	14.8	9.6
Resistance (Ω)	1.33	3.9	0.81	2.5
Inductance (mH)	2.67	9.35	0.7	2.5
Torque constant (Nm/A)	0.0268	0.0527	0.027	0.052
Electrical time constant (ms)	2	2.4	0.85	1
Mechanical time constant (ms)	20	15	16	13
Thermal time constant (min)	12	12	26	21
Inertia (g.cm ²)	105	110	140	140
Weight (g)	400	400	640	640
No of segments	8	8	8	8
Service life (h)	3000	3000	3000	3000
Sintered bronze bearings	✓	✓	✓	✓
Wires length (mm)	200	200	200	200

Product adaptations

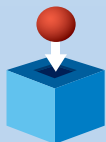

- Special output shafts
- Pinion or bush on output shaft
- Special supply voltages
- Special cable lengths
- Special output bearings
- Optional encoder
- Special mounting plate
- Customised electronics
- Special connectors

To order, see page 13

Curves

A - Torque/Speed curves
B - Torque/Current curves

82 800 8

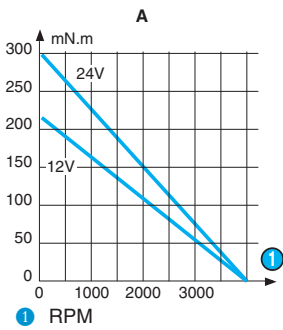

82 800 8

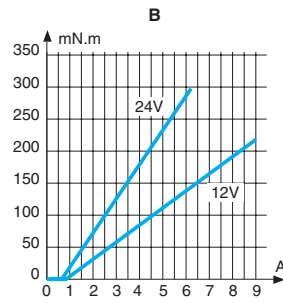

82 850 0

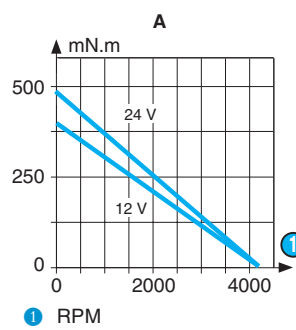

82 850 0

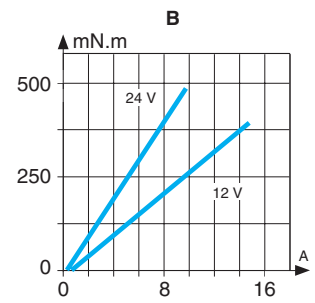

Dimensions

82 800 8

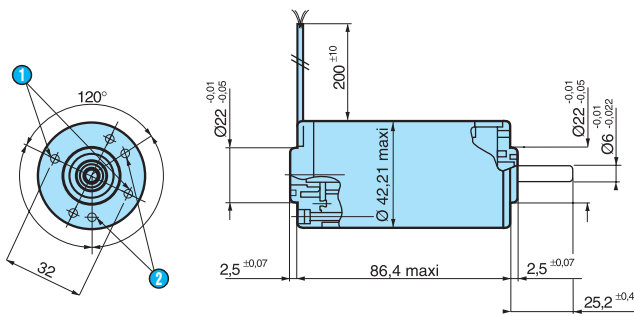

- 1 2 holes M3 x 0.5 at 180° depth 5 on Ø 32
- 2 2 holes 2.75 ±0.05 at 120° depth 5 mm on Ø 32
- 3 2 holes M3 x 0.5 at 180° depth 5.5 on Ø 32
- 4 2 holes M3 x 0.5 at 120° depth 5.5 on Ø 32

82 850 0

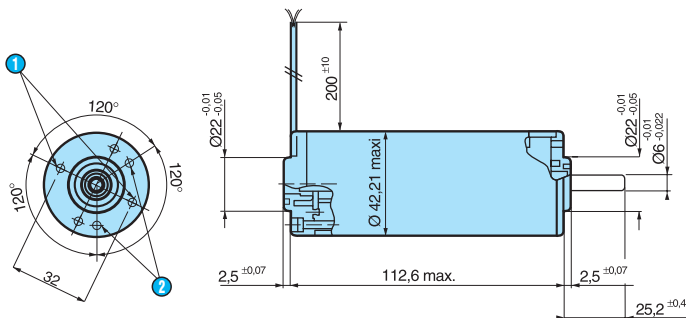

- 1 2 holes M3 x 0.5 at 180° depth 5 mm on Ø 32
- 2 2 holes 2.75 ± 0.05 at 120° depth 5 mm on Ø 32
- 3 2 holes M3 x 0.5 at 180° depth 5.5 mm on Ø 32
- 4 2 holes M3 x 0.5 at 120° depth 5.5 mm on Ø 32

D.C. direct drive brushed motors

→ Ø 63 mm 33 to 67Watts

- A range of D.C. direct-drive brushed motors with a case diameter of 63 mm and 33 to 67 W output power. Available in either 12, 24 or 48V D.C. versions.
- Ball bearings on output shaft
- Supply connection by 2 leads

Specifications

	33 watts	33 Watts	67 Watts	67 Watts
Type	82 830 0	82 830 0	82 830 5	82 830 5
Voltage	12 V	24 V	12 V	24 V
Part numbers	82 830 009	82 830 010	82 830 501	82 830 502
No-load characteristics				
Speed of rotation (rpm)	2100	2100	3400	3660
Absorbed power (W)	4.8	4.8	12.6	12
Absorbed current (A)	0.4	0.2	1.05	0.5
Nominal characteristics				
Speed (rpm)	1500	1500	2630	2770
Torque (mN.m)	172	172	170	170
Usable power (W)	27	27	47	50
Absorbed power (W)	43	45	72	72
Absorbed current (A)	3.6	1.9	6	3
Gearbox case temperature rise (°C)	50	50	46	50
Efficiency (%)	62	60	65	69.4
General characteristics				
Insulation class (conforming to IEC 85)	F (155 °C)	F (155 °C)	F (155 °C)	F (155 °C)
Protection (IEC 529) Terminal	IP20	IP20	IP20	IP20
Max. output (W)	33	33	67	67
Start torque (mN.m)	600	600	750	700
Starting current (A)	12	6.2	23.1	11.8
Resistance (Ω)	1	3.9	0.52	2.03
Inductance (mH)	1.4	6.4	1.19	4.68
Torque constant (Nm/A)	0.0517	0.1	0.034	0.0619
Electrical time constant (ms)	1.4	1.64	2.3	2.3
Mechanical time constant (ms)	19	19	33	33
Thermal time constant (min)	37	37	20	18
Inertia (g.cm ²)	514	492	520	500
Weight (g)	840	840	840	840
No of segments	12	12	12	12
Service life (h)	5000	5000	4000	4000
Ball bearings	✓	✓	✓	✓
Wires length (mm)	200	200	200	200

Product adaptations

- Special output shafts
- Pinion or bush on output shaft
- Special supply voltages
- Special cable lengths
- Special output bearings
- Optional encoder
- Special mounting plate
- Customised electronics
- Special connectors

Curves

A - Torque/Speed curves
B - Torque/Current curves

82 830 0

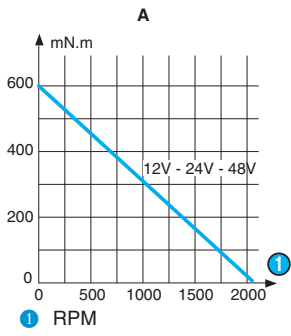

82 830 0

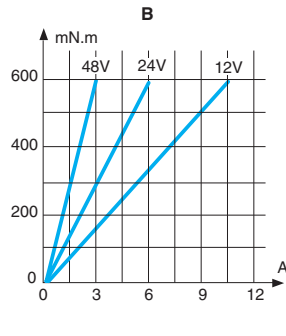

82 830 5

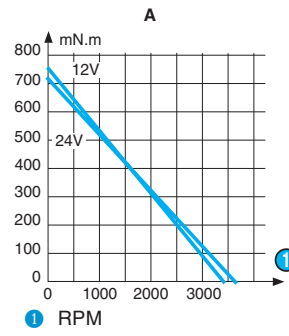

82 830 5

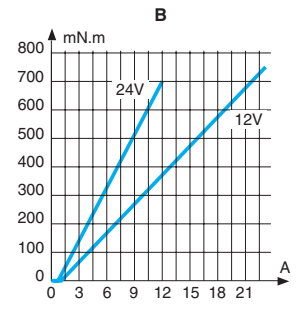

Dimensions

82 830 0

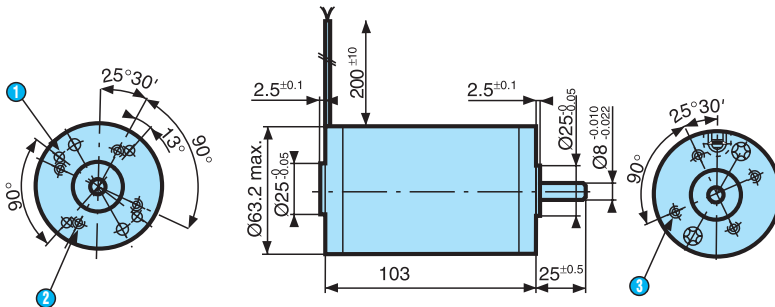

- 1 4 holes $\text{Ø } 3.65 \pm 0.05$ at 90° on $\text{Ø } 48$
- 2 4 holes M5 on $\text{Ø } 40$ depth 7 mm
- 3 4 holes M5 on $\text{Ø } 40$ depth 7 mm

D.C. direct drive brushed motors

→ Ø 63 mm 194 to 255 Watts

- A range of D.C. direct-drive brushed motors with a case diameter of 63 mm and between 194 and 255 Watts output power. Available in either 24 or 48V D.C. versions
- Ball bearings on output shaft
- Supply connection by 2 leads



Specifications

	194 Watts	255 Watts
Type	82 890 0	82 890 0
Voltage	24 V	48 V
Part numbers	82 890 001	82 890 002
No-load characteristics		
Speed of rotation (rpm)	3700	3750
Absorbed power (W)	10.8	9.6
Absorbed current (A)	0.45	0.2
Nominal characteristics		
Speed (rpm)	3200	3360
Torque (mN.m)	270	270
Usable power (W)	90	95
Absorbed power (W)	120	118
Absorbed current (A)	5.00	2.45
Gearbox case temperature rise (°C)	50	50
Efficiency (%)	75	80
General characteristics		
Insulation class (conforming to IEC 85)	F (155 °C)	F (155 °C)
Protection (IEC 529) Terminal	IP20	IP20
Max. output (W)	194	255
Start torque (mN.m)	2000	2600
Starting current (A)	34.1	21.7
Resistance (Ω)	0.7	2.2
Inductance (mH)	1.05	4.62
Torque constant (Nm/A)	0.059	0.12
Electrical time constant (ms)	1.5	2.1
Mechanical time constant (ms)	16	12
Thermal time constant (min)	41	36
Inertia (g.cm ²)	795	795
Weight (g)	1580	1580
No of segments	12	12
Service life (h)	5000	5000
Ball bearings	✓	✓
Wires length (mm)	200	200

Product adaptations

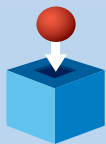

- Special output shafts
- Pinion or bush on output shaft
- Special supply voltages
- Special cable lengths
- Special output bearings
- Optional encoder
- Special mounting plate
- Customised electronics
- Special connectors

Curves

A - Torque/Speed curves
B - Torque/Current curves

82 890 0

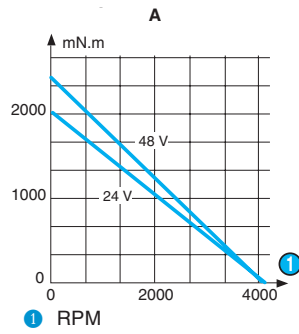

82 890 0

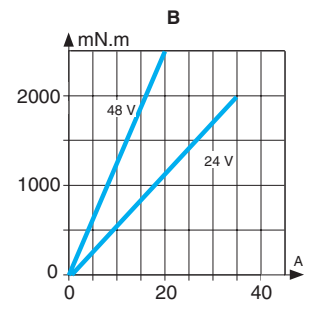

Dimensions

82 890 0

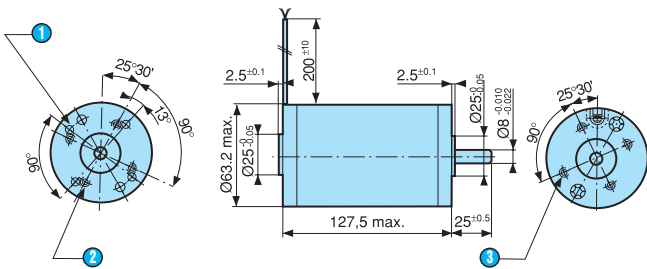

- ① 4 holes $\text{Ø } 3.65_{\pm 0.05}$ at 90° on $\text{Ø } 48$
- ② 4 holes M5 on $\text{Ø } 40$ depth 7 mm
- ③ 4 holes M5 on $\text{Ø } 40$ depth 7 mm

D.C. geared motors with brushes

→ 0.5 Nm 3.9 Watts

- A range of D.C. geared motors with sintered metal gears. Mechanical rating of gearbox with output shaft stalled : 0.5 Nm.
- 3.9 Watt motor power
- Available in either 12 or 24 V D.C. versions.
- Gearbox ratios options for 1.5 to 441 rpm.
- Options with magnetic encoder.



Specifications

		3.9 Watts	3.9 Watts
Type		82 862 0/2	82 862 0/2
Voltage		12 V	24 V
Output speed (rpm)	Ratios (i)		
441	9.76	82 862 001	82 862 004
141	30.6	82 862 002	82 862 005
45	95.4	82 862 003	82 862 006
14	298	82 862 201	82 862 204
5	931	82 862 202	82 862 205
1.5	2910	82 862 203	82 862 206
General characteristics			
Motor		82 860 0	82 860 0
Gearbox		81 012 0 / 81 012 2	81 012 0 / 81 012 2
Maximum permitted torque from gearmotor under continuous conditions (for 1 millions turns) N.m		0.5	0.5
Axial load static (daN)		1	1
Radial load static (daN)		8	8
Max. output (W)		3.9	3.9
Nominal output (W)		3	3
Gearbox case temperature rise (°C)		50	50
Weight (g)		160 / 170	160 / 170

Product adaptations

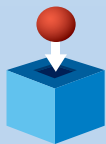

- Special supply voltages
- Special cable lengths
- Optional encoder
- Special connectors
- Special output shafts
- Special gearbox ratios
- Special gear wheel material
- Special output bearings
- Special mounting plate

Curves

The shaded zone represents the operating range of the geared motor.
 The horizontal line marks the maximum torque available in continuous duty cycle for a given life.
 For higher torque ratings, service life will be reduced.

Nominal speed and torque curves

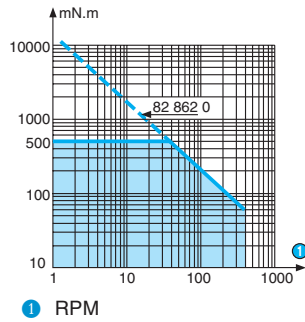

Dimensions

82 862 0

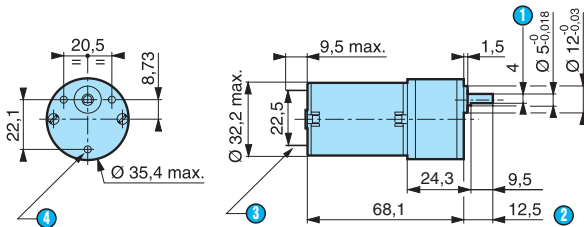

- 1 4 mm cross flats
- 2 (shaft pushed-in ←)
- 3 2 tags NFC 20-120 series 2.8 x 0.5 mm
- 4 3 holes M3 depth 4.5 mm

82 862 2

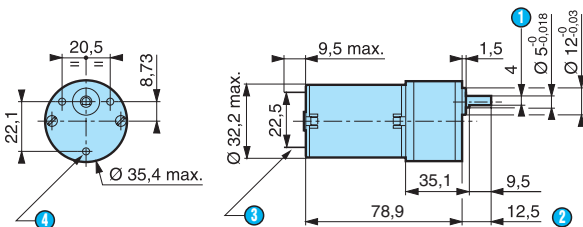

- 1 4 mm cross flats
- 2 (shaft pushed-in ←)
- 3 2 tags NFC 20-120 series 2.8 x 0.5 mm
- 4 3 holes M3 depth 4.5 mm